



Electrolux
PROFESSIONAL

PLUS - Static Preparation 1000 mm Passthrough Worktop Cupboard

ITEM # _____

MODEL # _____

NAME # _____

SIS # _____

AIA # _____

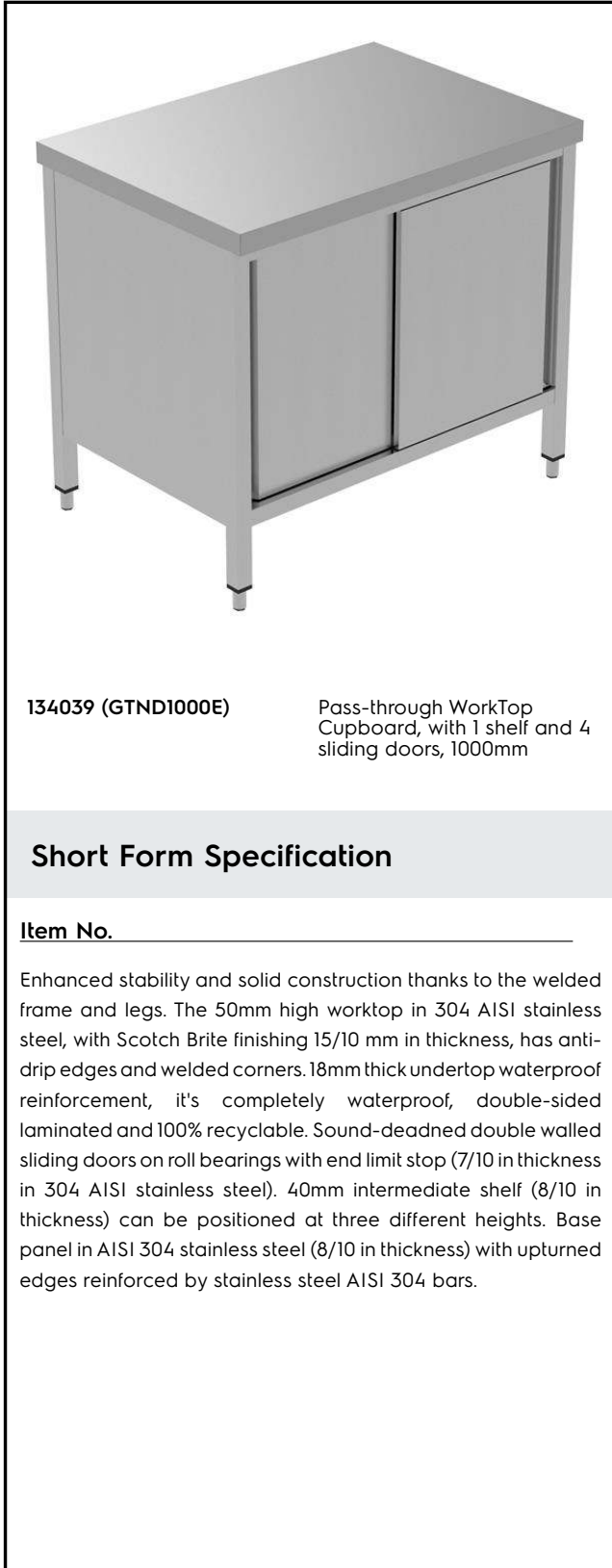

134039 (GTND1000E)

Pass-through WorkTop
Cupboard, with 1 shelf and 4
sliding doors, 1000mm

Short Form Specification

Item No. _____

Enhanced stability and solid construction thanks to the welded frame and legs. The 50mm high worktop in 304 AISI stainless steel, with Scotch Brite finishing 15/10 mm in thickness, has anti-drip edges and welded corners. 18mm thick undertop waterproof reinforcement, it's completely waterproof, double-sided laminated and 100% recyclable. Sound-deadened double walled sliding doors on roll bearings with end limit stop (7/10 in thickness in 304 AISI stainless steel). 40mm intermediate shelf (8/10 in thickness) can be positioned at three different heights. Base panel in AISI 304 stainless steel (8/10 in thickness) with upturned edges reinforced by stainless steel AISI 304 bars.

Main Features

- Enhanced stability and solid construction. Stability, loading and stress tests by external certified body.
- Product range suitable for international tenders requirements for intense usage installations.

Construction

- Welded frame and legs.
- Worktop with 50 mm high profile, in s/s Scotch Brite finishing, 15/10 in thickness with anti-drip edges and welded corners.
- Undertop is 18mm in thickness, reinforced, completely waterproof, double-sided laminated and 100% recyclable.
- Doorsliding system is fluent and reliable, tested with over 80.000 cycles by external certified body.
- Sliding doors are in stainless steel and double-walled with sound-deadening material inside. They are 7/10mm in thickness with roll bearings and end limit stop.
- Cupboard interior has easy access thanks to completely openable doors.
- Intermediate shelf has 40mm high profile, is 8/10 in thickness with upturned edges and bar reinforcement. It can be positioned at three different heights.
- Base panel has 40mm high profile, is 8/10 in thickness with upturned edges and bar reinforcement. It is welded to legs for further structure reinforcement.
- Height-adjustable stainless steel feet (-20/+30mm).
- Constructed entirely in 304 AISI stainless steel.

Optional Accessories

- Set of 4 wheels (2 with brake), PNC 855207 diameter=125mm

APPROVAL: _____



Experience the Excellence
www.electroluxprofessional.com

Key Information:

Cabinet width:		
134039 (GTND1000E)	918 mm	
Cabinet depth:	580 mm	
Cabinet height:	580 mm	
External dimensions, Width:	1000 mm	
External dimensions, Depth:	700 mm	
External dimensions, Height:	900 mm	
Number and type of doors:	4 Sliding	
Worktop thickness:	50 mm	
Net weight:	61 kg	
Adjustable Feet	-20/+30 mm	

